



Truck Trailed Mechanical Sweeper



Cammello is designed for heavy works and is capable of sweeping every kind of debris such as sands, waste generated as a result of recovery of heavy winter conditions, mass of household garbages, stones.

It can collect 1,2 ton per minute waste materials from surface and It doesn't need to be taken to discharge areas.

It loads coarse waste material quickly and directly from the road onto a truck and operates on a mechanical basis without suction.

It is ideal for use in long distances and heavy road conditions.



Cost of Ownership: Cammello offers the optimum balance among high performance, quality, low cost, and environmental impact.

Components: Çeksan, making no occasions on quality, cooperate with suppliers that became marks in their sector. We select the machine parts from suppliers who have proven themselves in their sector with their quality, price and widespread agent network.

Short Term Lead Time: Çeksan has flexible production plans in order to provide delivery terms shorter than average of the sector.

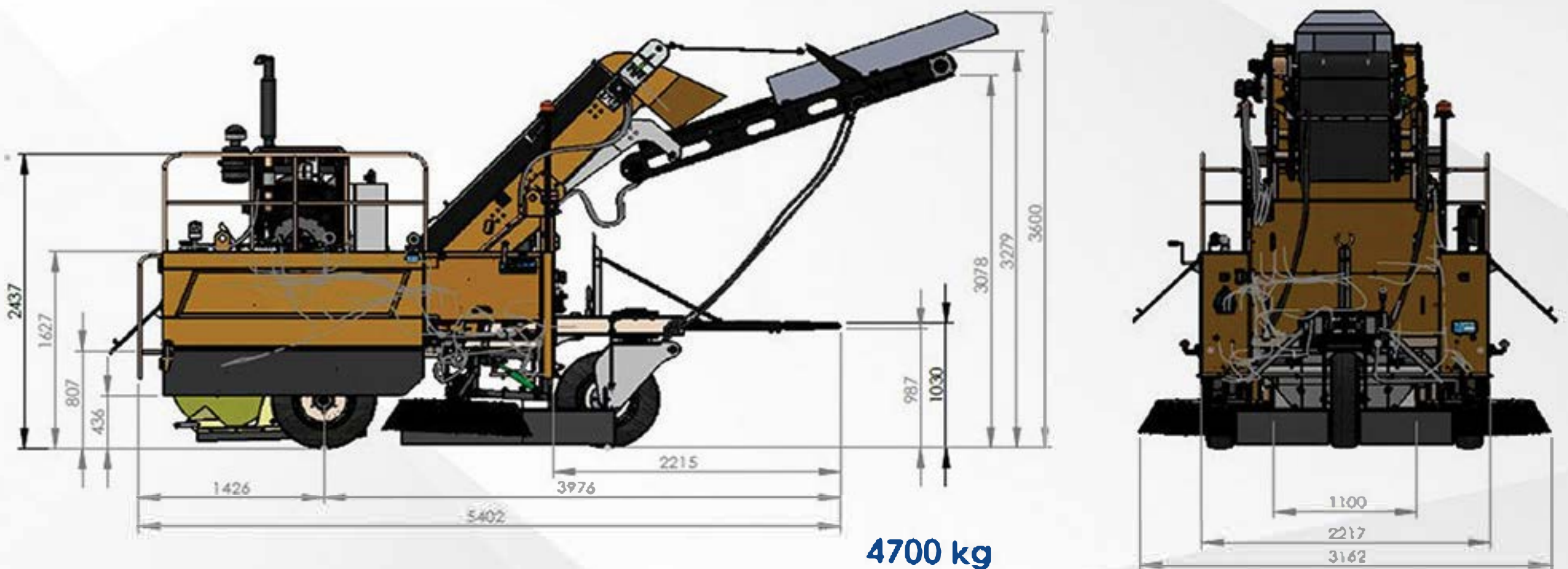

Body & Design: Cammello is robustly constructed from quality materials to provide years of continuous performance and reliable service.

Blasting and painting operations are implemented carefully, and special covering solutions are provided for the materials.

All the materials are 100% recyclable.

The machine is easily operated and cleaned due to its aesthetic design.

-  Water Tank
-  Oil Tank
-  Fuel Tank
-  Engine

Tanks: Cammello has two stainless steel water tanks which have total capacity of 1200 lt.

Oil tank capacity is 200 lt.

Fuel tank capacity is 200 lt.

Engine: Cammello has 75KW (105HP) diesel auxiliary engine which is infinitely variable ensuring optimum operational and fuel efficiency without compromising high performance. rpm of the engine is adjustable. Perkins® English brand or Deutz® German brand motors which meet the highest expectancies for emissions and environmental impact are used in order to provide maximum power and reduced fuel consumption. Turkish local engine or any other brands all over the world can be also chosen optionally by our partners.

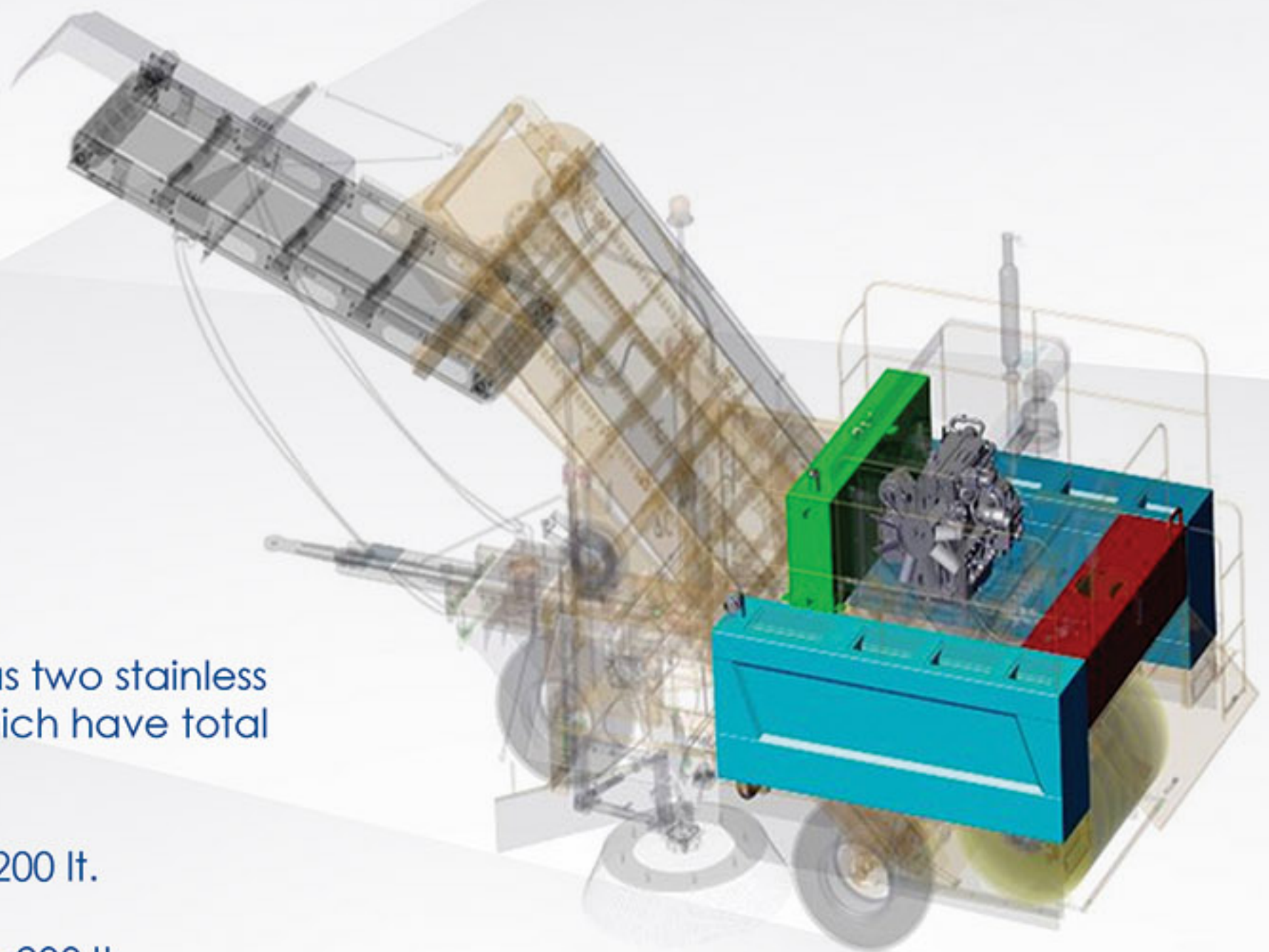

Elevator: It is equipped with abrasion-resistant spoons in order to collect all kind of bulky debris from the surface. Speed of elevator can be adjusted according to the density of waste



Conveyor Belt: Materials collected by the elevator is directly loaded onto the loading platform of the truck by conveyor belt. It can be adjusted in height and can hence be adapted to the loading height of the standard trucks used for towing



Aluminium Cover: Both elevator and conveyor belt are covered by aluminium material in order to prevent dust and shedding of the sands and other garbages while loading.



Transit: There is chain locking system on the machine, which assures brushes not to touch the surface during transportation and prevents from damages. The machine includes height adjustable tow bar, as well.



Brushes: Hydraulically actuated heavy duty brushes with ideal dimensions for each machine effectively collect all kind of debris from the road to front of elevator spoons. Down pressure of the brushes can be adjustable for extending product life.
Water Spraying System: Cammello has stainless steel water jets to prevent dust while working. Waste is humidified at correct points. The spray system is powered by high quality water pump.



High Pressure Washing Gun: Washing gun equipped on the machine can be used for cleaning the machine, irrigation of trees and plants, washing the pavements or bus stations.



**Çeksan in more than
50 countries in 6 continents**

Easy to Control: Ergonomic and user friendly pendant control connected via a flexible cable allow the driver to run all the functions of sweeping. Second control panel is also fixed on the machine. Since its use and maintenance is very easy operator can learn operating the machine after a few hours of training.

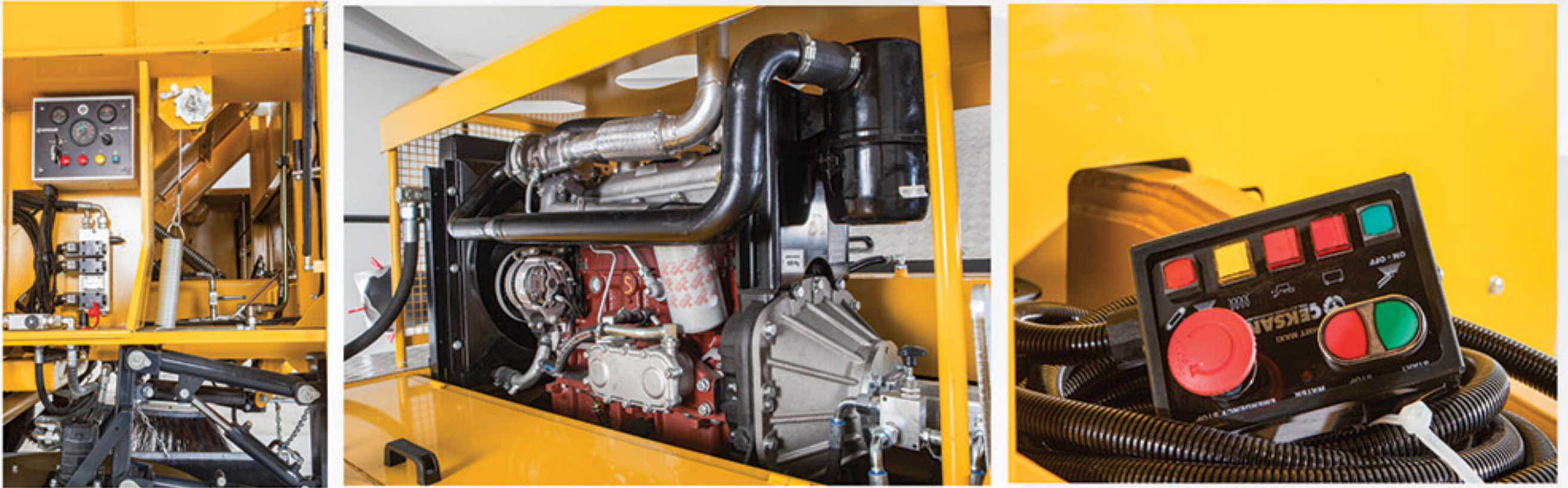

Easy to Maintain: All critical controls are contained in a purpose built locker on the one side of the machine. The ease of access to this equipment aids diagnostic checks and maintenance. Heavy duty, waterproof electrical connectors and color coded wires have stamped identification for quick location during troubleshooting. Due to compact design of the subgroup, it is very easy and quick to change the brushes, and to clean jet nozzles, and water filter.

Options in Cammello

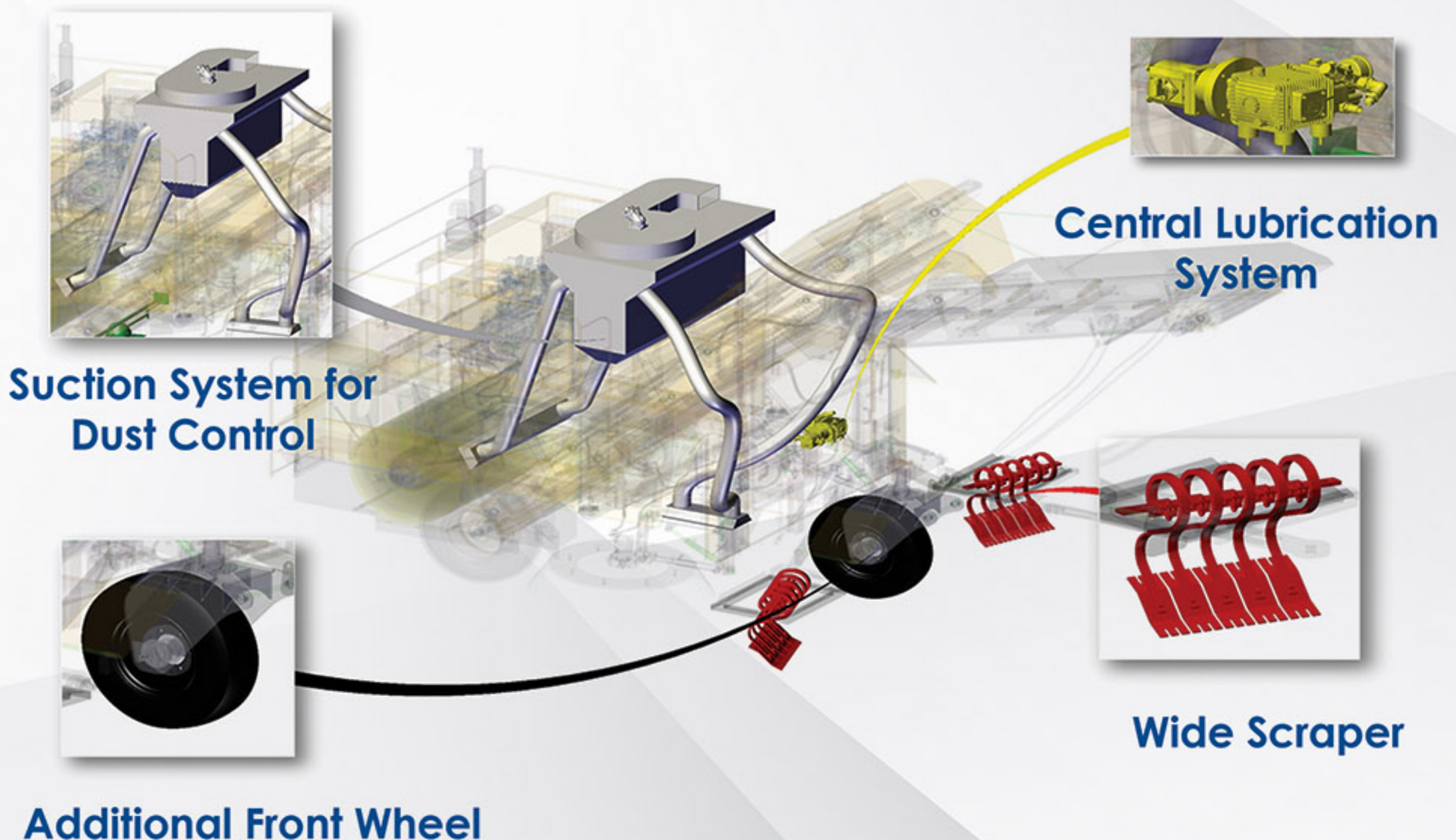



Service and After Sales: Çeksan organizes periodical trainings for operators, shares all maintenance schedule as earlier as sales process in order to ensure full valid warranty conditions, and establishes an easily and fast accessible network for spare parts supply. When a technical issue rises beyond capabilities of customers to solve, our company provides in place support thanks to expert team within company organization. Whole product range is assured under Çeksan warranty conditions. We guarantee 10 year spare part supply to our partners.

Sweeping Speed (km/h)	0-15
Sweeping Width (mm)	3162
Sweeping Capacity (m ² /h)	47432
Waste Loading Capacity (ton/min)	1,2
Water Tank Capacity (liter)	1200
Hydraulic Oil Tank Capacity (liter)	200
Fuel Tank Capacity (liter)	200
Machine Length (mm)	6500
Machine Width (mm)	2217
Machine Height (mm)	3600
Empty Total Weight (kg)	4700
Water Pump (bar)	100
Side Brush Diameter (mm)	1000
Rear Brush Diameter (mm)	900
Rear Brush Length (mm)	1150
Tire	215/75R17.5
Auxiliary Engine Type	Diesel
Auxiliary Engine Power (kw)	75

Çeksan has been producing sweepers since 1989. We are the member of European Association of Municipal Equipment Manufacturers (EUnited) and our plant is accredited to ISO 9001 Quality Management, ISO 14001 Environmental Management, OHSAS 18001 Occupational Health & Safety Management Systems, and TSE Service Qualification System. Whole Cammello product range has CE marking.

Çeksan Research & Development Center officially certified by Ministry of Industry designs and simulates the sweepers with innovative technical tools and software before production. All customized products are manufactured in our factory without outsourcing in order to satisfy customer quality expectations and standards.



ISO 9001



ISO 14001



OHSAS 18001



CE CityRay



CityMouse



CE Cammello



CE Hamarat



CE BatteryFly



CE SmartBee



TSE



PM 10



R&D Center